

R180

SKID LOADERS



GEHL®

Capacities		Metric
Rated Operating Capacity		817 kg
Unladen weight		2892 kg
Tipping capacity		1633 kg
Weight and dimensions		
Overall Operating Height - Fully Raised	h27	3876 mm
Height to Hinge Pin - Fully Raised	h28	3023 mm
Overall Height to top of ROPS	h17	1948 mm
Dump angle at full height	a5	38 °
Dump height	h29	2379 mm
Overall length with bucket	l16	3139 mm
Dump reach - Full height	r6	579 mm
Rollback at ground	a13	28 °
Rollback Angle at Full Height	a4	99 °
Seat to ground height	h30	930 mm
Wheelbase	y	988 mm
Overall width less bucket	b1	1582 mm
Bucket Width	e1	1562 mm
Ground clearance	m4	160 mm
Overall length - Less Bucket	l2	2425 mm
Departure angle	a2	19 °
Clearance Radius - Front with Bucket	b18	1869 mm
Clearance Circle - Front without Bucket	b19	1130 mm
Clearance Circle - Rear	wa1	1519 mm
Performances		
Travel speed (unladen)		12.60 km/h
Wheels		
Standard tires		10 x 16.5 - 10 PR HD
Engine		
Engine brand		Yanmar
Engine model		4TNV98-ZNMS3R1
Engine norm		IT4, Stage IIIA
Gross Power		52.10 kW
Net Power		51.20 kW
Max. torque / Engine rotation		241 Nm / 2500 rpm
Power source		Diesel
Number of cylinders		4
Battery voltage		12 V
Accessory plug		12 V
Alternator - Ampere		100 A
Starter		3 kW
Hydraulics		
Standard flow - Auxiliary hydraulics		71.40 l/min
Auxiliary Hydraulic Pressure		207 bar
High-Flow Auxiliary Hydraulics - Option		114 l/min
Tank capacities		
Fuel tank		62.50 l
Hydraulic oil tank capacity		41.60 l
Displacement		3.30 l
LH Chain case		8.50 l
RH Chain case		8.50 l

R180 - Dimensional drawing

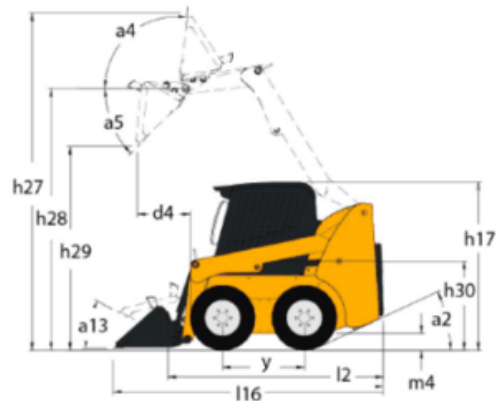
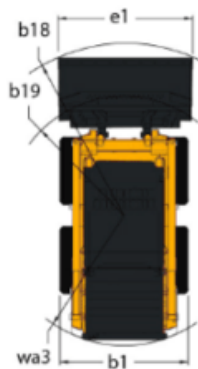



GEHL®

Siège Social
P.O. Box 179 - One Gehl Way - West Bend, WI, USA 53095
Tel: (262) 334-9461 - Fax: (262) 338-7517
www.gehl.com



This brochure describes versions and configuration options for Gehl products which may be fitted with different equipment. The equipment described in this brochure may be standard, optional or not available depending on version. Gehl reserves the right to change the specifications shown and described at any time and without prior warning. The manufacturer is not liable for the specifications given. For more information, contact your Gehl dealer. Non-contractual document. Product descriptions may differ from actual products. List of specifications is not comprehensive. The logos and visual identity of the company are the property of Gehl and may not be used without authorization. All rights reserved. The photos and diagrams contained in this brochure are provided for information only.

MANITOU EQUIPMENT AMERICAS, LLC - Limited company with board of directors - Share capital: 39,668,399 euros - 857 802 508 RCS West Bend